

HS-2200A-EL-W600 Technical Data Sheet

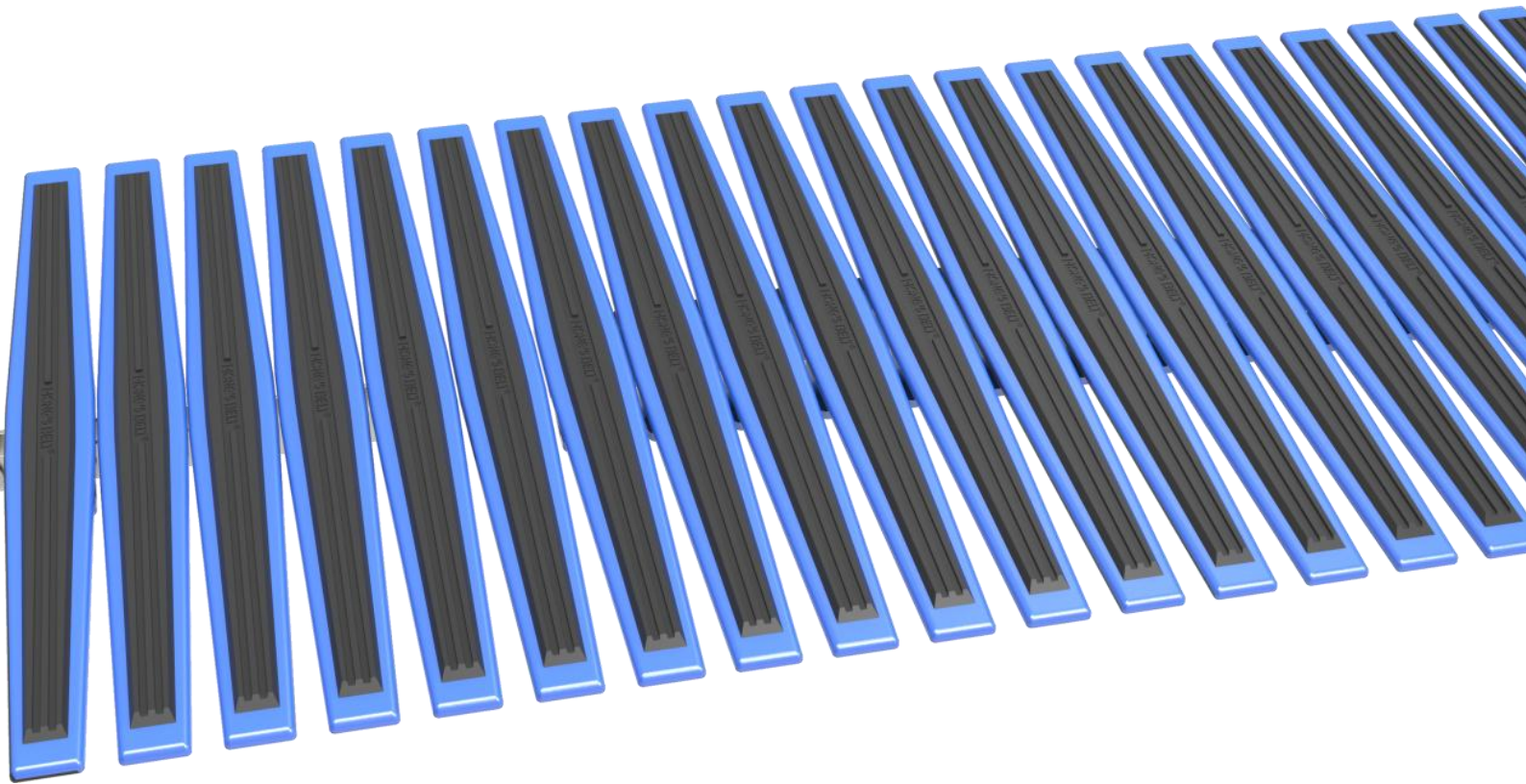

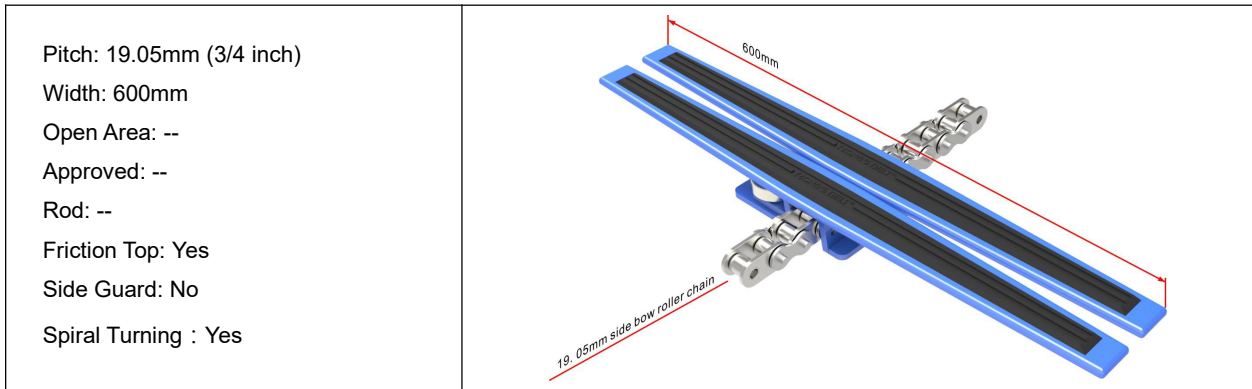

Data

Chain material	Chain Strength		Temperature		Turning Radius
	Strength (kgf)	Total load (kg)	°C (min.)	°C (max.)	mm (Min)
Carbon steel	3500	600	-40	93	650
Stainless steel	2800	480	-40	93	650

Color Table

Polypropylene					Polyethylene					Acetal				
W	G	N	DB	B	W	G	N	DB	B	BL	G	N	DB	B
										●				●

W-White, G-Gray, N-Nature, DB-Dark brown, B-Blue, BL-Black (For more information of belt color, pls consult our sales team)

Note

1. Max length of carbon steel chain: 60meters, Max length of stainless steel chain: 45meters.
2. Max speed: 60M/min.
3. The packaging of chain: 3.048M/pc.

About HS-2200A-EL Spiral Plate Chain

HS-2200A-EL Spiral Plate Chain is in common use with other spiral plate chains in the market, especially for 3/4 inch pitch type, even other brand can choose HS-2200 Spiral Plate Chain as its replacement in maintenance.

Features of HS-2200A-EL Spiral Plate Chain Conveyors

HONG'S BELT is specialized in the production of spiral conveyors, which adopt HS-2200A-EL Spiral Plate Chain, it is a well-designed and good-quality conveying system. Drive chains of it are special grade 3/4 inch side bend chain, and the tensile strength is much bigger than other brand in the market.

- HS-2200A-EL Spiral Plate Chain Conveyors can achieve upward or downward extended conveying in the least space, and save lots of space, so meet the demands of automatic warehouse system, fluctuation floor continuous conveying, temporary storage, cooling hysteresis etc. well.
- HS-2200A-EL Spiral Plate Chain Conveyors adopt slim design, the total weight is reduced, but still have big load capacity, the load efficiency will not be affected for the light weight of conveyor. The simplified structure is easy to lubricate and maintain. (For related design parameters, please consult our customer service department).

Size Description of HS-2200A-EL Spiral Plate Chain Conveyors

- The standard width of HS-2200A-EL Spiral Plate Chain Conveyors is 620mm (effective width is 600mm) Please confirm the size of each parts with us according to the following graphical representation before adoption.

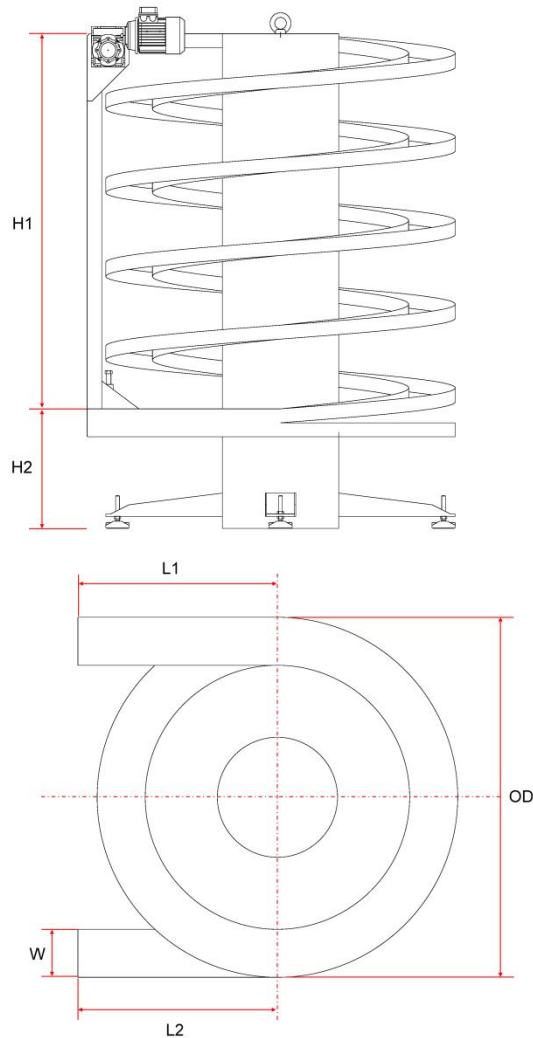

■ Height and number of winding

1. Please fill in the winding height H1, bottom roller height H2, as well as the conveying requirement for up or down.

2. The Max production height of this spiral conveyor is 6M, and the Max number of winding is 10, for angle change because of different height and number of winding, please consult our customer service department.
3. External dimension of this spiral conveyor (OD) is 1920mm; For transport direction Mode N, please refer attached table and graphical representation.
4. Please specify the angle which can ensure the smooth lifting of goods to be transported, or specify the material of goods to be transported which touch with the conveyor belt.
5. Please specify the volume as well as the direction of goods to be transported.
6. Please specify dry & wet environment and temperature difference of the conveyors' operating environment.
7. Please specify the power supply voltage and current frequency.

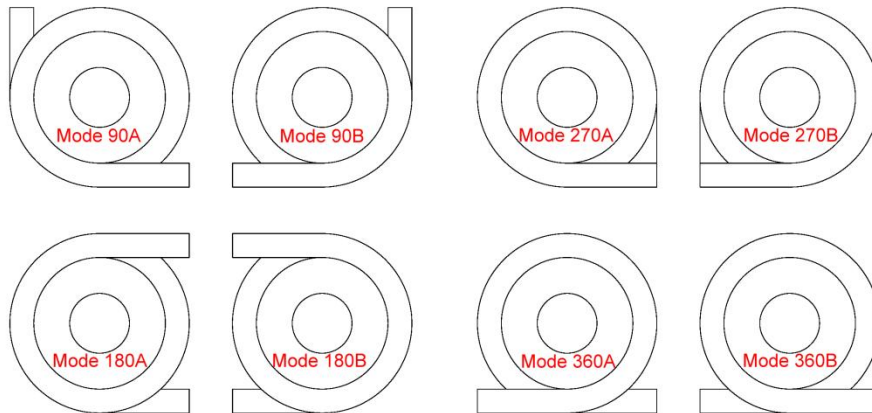

■ Biggest Load Capacity

1. This spiral conveyor can be made from Carbon steel, stainless steel and other materials; it depends on the conveyors' operating environment. Carbon steel chains and Stainless steel chains are also available for driving.
2. Max Load capacity of Carbon steel chains is 750KG, Max Load capacity of Stainless steel chains is 600KG, please pay special attention to it.
3. Please specify Max load capacity and running speed of conveyor belt for us to match optimal motor for you; if the running speed is adjustable, also please indicate it in advance for us to equip speed control system for you.
4. Max running speed of this conveyor is 60M/min, automatic lubricating device is necessary to be installed if the speed exceeds 30M/min.